



Save These Instructions for Future Reference



Elux 115

ALL CONNECTIONS TO BE CARRIED OUT BY A QUALIFIED ELECTRICIAN
PLEASE READ CAREFULLY BEFORE STARTING INSTALLATION.



WARNING

ELECTRIC SHOCK HAZARD
This equipment is to be serviced by trained personnel only.

Remote Driver / Electronic Control Device

Elux 115

Save These Instructions for Future Reference

Electrical products can cause death, injury, or damage to property. Installation of this product must be carried out by a qualified electrician, in compliance with SANS 10142 or corresponding regulations of the country of installation.

On completion of installation, the Certificate of Compliance must be updated.

For non user replaceable light source: The light source contained in this luminaire shall only be replaced by the manufacturer or his/her service agent or a similar qualified person

WARNING: TO AVOID FIRE, SHOCK OR DEATH
TURN OFF POWER AT CIRCUIT BREAKER OR FUSE AND TEST THAT THE POWER IS OFF BEFORE WIRING

ALL LUMINAIRES SUPPLIED AND TO BE INSTALLED ABOVE AND BELOW 5 METERS ARE IN COMPLIANCE WITH SANS 60598 SECTION 3.5.6 ACCORDING TO THE MANUFACTURER GUARANTEE AND WARRANTY

Regent Lighting reserves the right to change specifications modify designs and discontinue items without incurring obligation and whilst every effort is made to ensure that descriptions, specifications and other information in this catalogue are correct, no warranty is given in respect thereof and the company shall not be liable for any error therein.

www.regentlight.co.za

REGENT LIGHTING A DIVISION
OF WAHL INDUSTRIES.

3 - 13 MAIN REEF SERVICE ROAD, CORNER
SPRINGBOK AND MAIN REEF ROAD, INDUSTRIAL,
JOHANNESBURG, SOUTH AFRICA.
TEL : +27 11 474 0171

January 2021

INSTALLATION INSTRUCTIONS

PLEASE READ CAREFULLY BEFORE STARTING INSTALLATION.
ALL CONNECTIONS TO BE CARRIED OUT BY A QUALIFIED ELECTRICIAN



WARNING

ELECTRIC SHOCK HAZARD
This equipment is to be serviced by trained personnel only.

Remote Driver / Electronic Control Device

DO NOT CONNECT THE FITTING LIVE

1

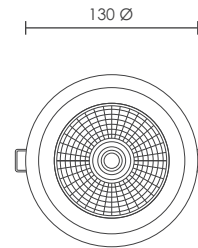

Bottom View

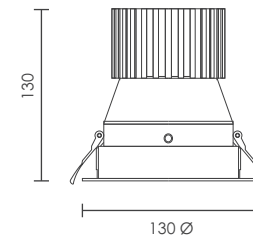

Side View

Requirements:

- **Be sure the electricity to the system you are working on is isolated.**
- **If the main supply power (live) is on, it will cause damage to the luminaire.**

WARNING: Do not cover recessed Luminaire with Thermal Insulating material.

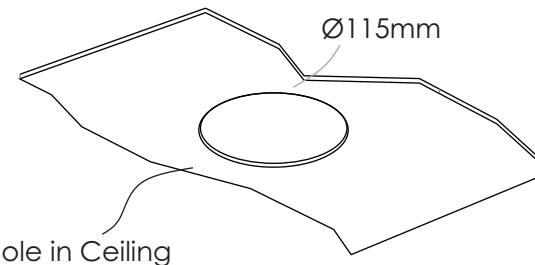

Cut Hole in Ceiling

1. Select the required position for the luminaire

Mark the position and cut a Ø115mm hole in the ceiling.

Ensure luminaire is not covered with thermal insulating material



Do not cover
with Thermal
insulation material

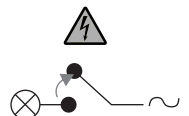



Important Safety Instructions

- This product should be installed by a competent person i.e. Qualified electrician.
- This product requires a constant stable electrical supply 220V - 240V VAC 50Hz - alternating current.
- The product must be regularly maintained, including the replacement of lamps/LED timeously.
- This product could be HAZARDOUS if not used correctly, it could cause electric shock, serious bodily harm or death.
- This product is not a toy, please keep away from children.
- This product may contain small parts that can be swallowed.



- Use only the correct light bulbs/LED as stipulated on the carton for the product.
- Any modifications of this product after supply will result in the guarantee being void.
- Spare parts may become unavailable over time. Items can vary slightly from the picture on the carton
- Coastal humidity can affect the longevity of the light fitting over time.
- Be sure to follow the steps in the order given.
- Read instructions carefully.

2

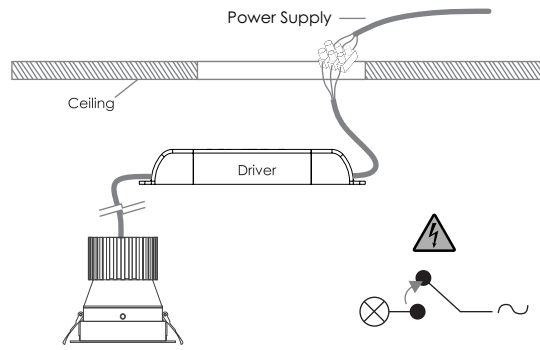

2. Connect the Switched Live (S/A), Neutral (N) and Earth (E) cable(s) to the terminal block.

SWITCHED LIVE – (Red or Brown) to terminal marked L
 NEUTRAL – (Black or Blue) to terminal marked N
 EARTH – (Green/Yellow) to terminal marked E.

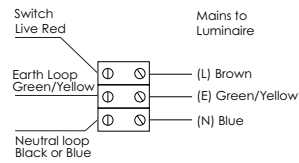

5

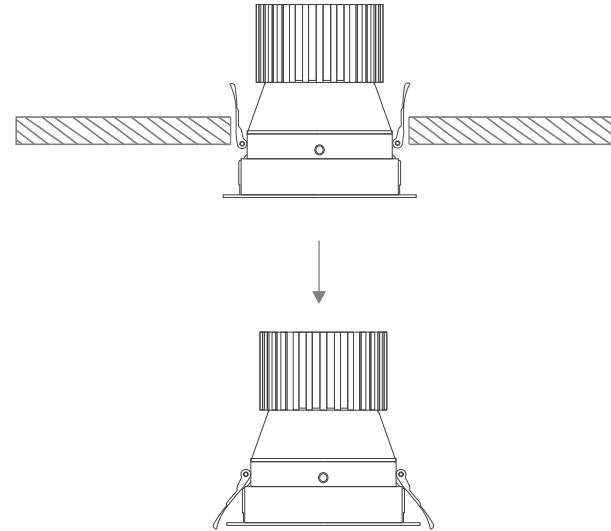

5. To install or change the fitting, catch and pull the fitting from the ceiling.

Ensure the new lamp is the correct wattage

3

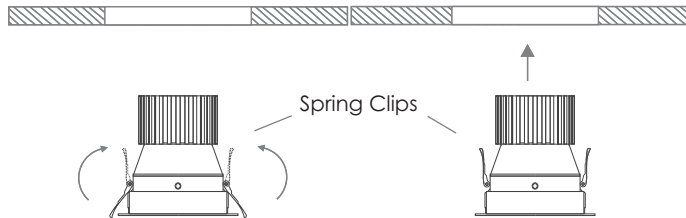

3. Push both spring clips on the side of the fitting and push the fitting into the ceiling.

Ensure there is no pinched insulation

4

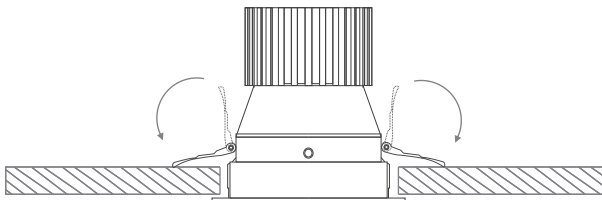

4. Ensure spring clips release in the ceiling.



6

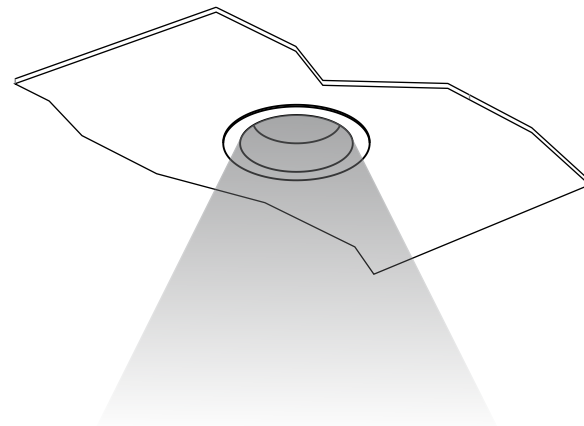

6. Switch on the power supply.

